

TSOP 40-SD

Memory Footprint

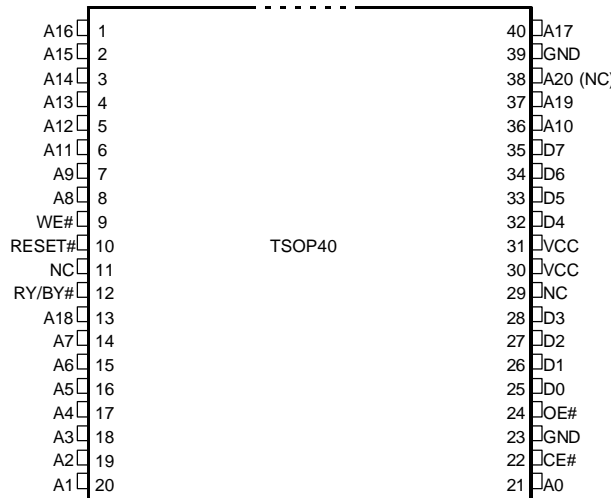

- ❑ 40 pin TSOP, 8 bit memories
- ❑ Probe solders directly to PCB
- ❑ Max memory size 1M Bytes
- ❑ Organized as 1M x 8 bit
- ❑ Maximum PromICE: P1080
- ❑ For 3 Volt parts, use the 3 volt adapter (GEI Part # 3VA8).

Note: Maximum memory size is shown in footprint. For smaller memories, unused lines must be connected to V_{cc} to ensure proper PromICE operation.

TSOP Flex Probe

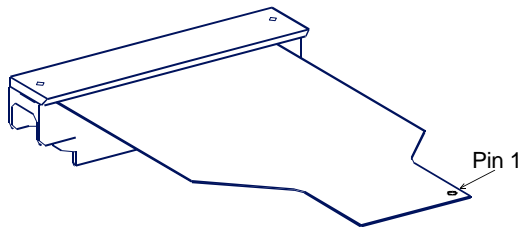

Correct Probe – The probe shipped with this cable is designed to be soldered directly to the PCB. Instructions for soldering are included with the probe.

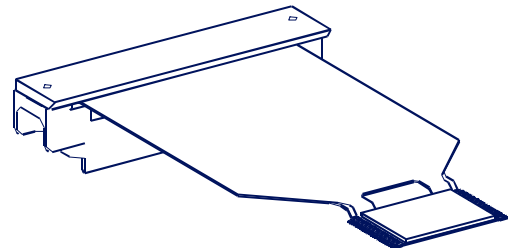

Wrong Probe – This style of probe is intended for insertion in a Meritec socket. If you received this probe in error, do not attempt to solder it to your PCB. Contact Grammar Engine for an exchange.

Complete Cable Assembly

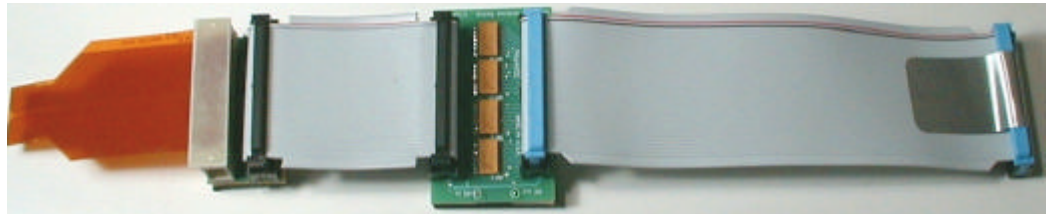

Memories Supported

- ❑ www.promice.com/memories.htm contains a listing of all memories supported by Grammar Engine target cables. **Note:** This cable supports both ROM and flash memories. Flash signals RY/BY#, RP#, WP#, 3/5#, VPP, BYTE#, and RESET# are shown on the cable schematic but are not connected to PromICE. PromICE emulates Flash memory as a ROM when used with this cable.
- ❑ Emulates devices like 28F002B~004B; 29LV080; 29CV008 and others.

**For Technical Support, contact Grammar Engine at 614-899-7878 or support@gei.com
For Sales, contact Grammar Engine Inc. www.gei.com or 1.800.PROMICE.**

Notes and Precautions

Always turn target power OFF when connecting or disconnect PromICE target cables.	If your target has capacitors, allow sufficient discharge time. Connecting with the power on can damage cables or the PromICE.
Handle the TSOP Flex Probe with care.	Carefully review the flex probe application notes (under the foam in the plastic box) before proceeding. Damage to the flex probe through mishandling is not covered in your PromICE warranty or support policy. Once the seal on the case is broken, Grammar Engine Inc. cannot accept returns of flex probes.

Installation Instructions

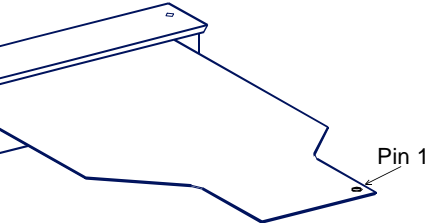
Step	Action	Notes
1.	Verify that you have the correct cable for the memory you are emulating.	If you have the wrong cable, contact Grammar Engine or your distributor for a replacement.
2.	Align Flex Probe and TSOP mounting pads on the PCB.	Remove the TSOP Flex Probe from its protective case. Locate pin 1 on the probe and identify the corresponding pad on your PCB
 <p>The diagram shows a perspective view of the TSOP Flex Probe. It is a long, thin, rectangular component with a central section that is wider and has a notch. One end has a connector. A small circle on the top surface is labeled 'Pin 1'.</p>		<p>If you are unsure of the correct orientation, consult the cable schematic and the schematic of your target board.</p> <p>Important Note: The solder-down flex probe must be connected directly to the pads on your PCB. It <u>cannot</u> be soldered over a memory.</p>
		3.
4.	Connect PromICE.	With the power off to your PromICE, connect the shielded ground plane cables to your PromICE.
5.	Connect the adapter board to the Flex Probe.	Connect the Flex Probe to the identical connector on the adapter board. (These connectors are identical but they fit together - line up the keys and slide the connector on the Flex Probe straight down onto the adapter board's connector.)

You are now ready to power up your target and PromICE. Please consult your PromICE manual for further setup information.

**For Technical Support, contact Grammar Engine at 614-899-7878 or support@gei.com
For Sales, contact Grammar Engine Inc. at www.gei.com or 1.800.PROMICE.**

Contact your Grammar Engine Sales Representative to order these parts and accessories:

Cable Parts	TSOP 40 BD 34FFEXT 34FF6.7EXT TSOP 40 SDH	Adapter Board 6" Shielded Ground Plane Cable 6.75" Shielded Ground Plane Cable 40 pin TSOP solder-down flex probe (AlpTex #923706-40)
Accessories	3VA8	3 Volt Adapter

For Technical Support, contact Grammar Engine at 614-899-7878 or support@gei.com
For Sales information, contact Grammar Engine Inc. at 1.800.PROMICE.

TSOP40

8-bit

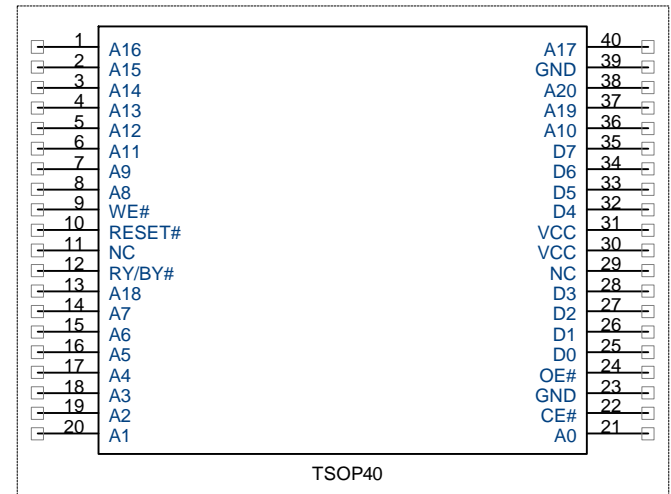
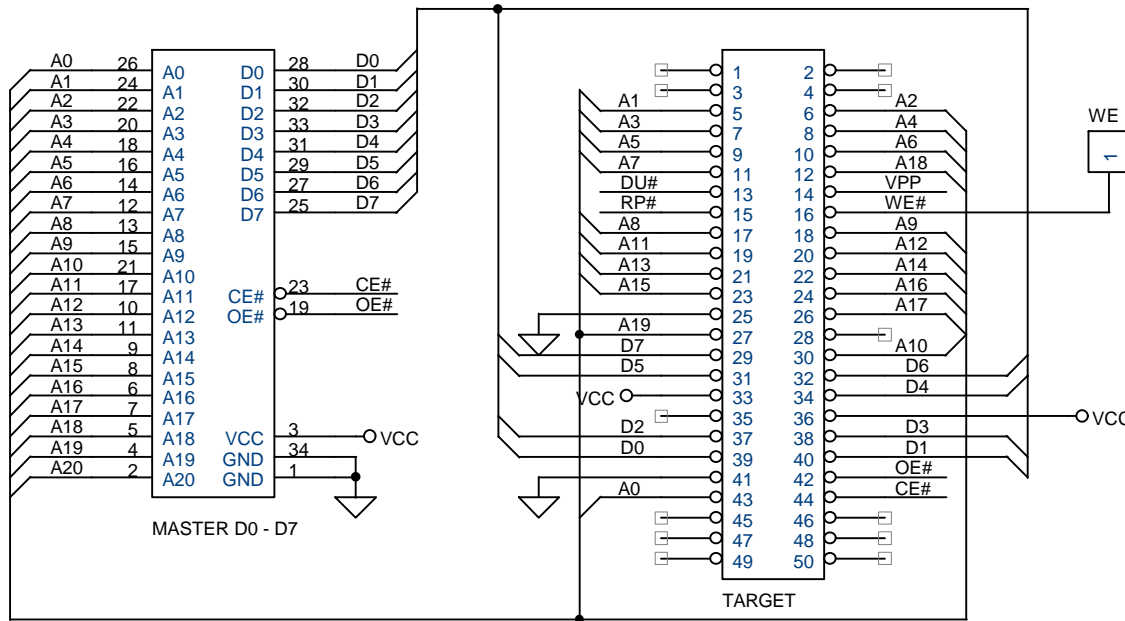

NOTES:

MAX SIZE: 1MB (P1080)
SUPPORTS: 8 bit 40 pin TSOPs
PROMICE JUMPER SETTING: 32

DU#, RP#, and VPP not connected

Grammar Engine, Inc.

921 Eastwind Drive
 Suite 122
 Westerville, OH 43081

Title

TSOP40

Size	Document Number	Rev
A	041-0001	1.0

Date: _____ Sheet _____ of _____

Tuesday, April 01, 1997

1

1